

SL05T1 Series

300 Watt, SOT-23 Low Capacitance TVS for High Speed Line Protections

This new family of TVS offers transient overvoltage protection with significantly reduced capacitance. The capacitance is lowered by integrating a compensating diode in series. This integrated solution offers ESD protection for high speed interfaces such as communication systems, computers, and computer peripherals.

Features

- TVS Diode in Series with a Compensating Diode Offers <5 pF Capacitance
- ESD Protection Meeting IEC 61000-4-2, 4-4, 4-5
- Peak Power Rating of 300 W, 8 × 20 μs
- Bi-Direction Protection Can Be Achieved By Using Two Devices
- Flammability Rating UL 94 V-0
- Pb-Free Packages are Available

Mechanical Characteristics:

CASE: Void-free, transfer-molded, thermosetting plastic case

FINISH: Corrosion resistant finish, easily solderable

MAXIMUM CASE TEMPERATURE FOR SOLDERING PURPOSES:

260°C for 10 Seconds

Package designed for optimal automated board assembly

Small package size for high density applications

Available in 8 mm Tape and Reel

Use the Device Number to order the 7 inch/3,000 unit reel.

Replace the “T1” with “T3” in the Device Number to order the

13 inch/10,000 unit reel.



ON Semiconductor®

<http://onsemi.com>

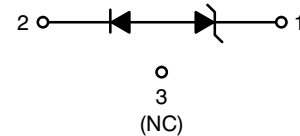

MARKING DIAGRAM

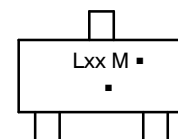
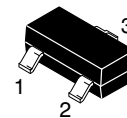

**SOT-23 (TO-236)
CASE 318
STYLE 26**

Lxx = Device Code
xx = 05, 15, or 24
M = Date Code*
▪ = Pb-Free Package

(Note: Microdot may be in either location)

*Date Code orientation and/or overbar may vary depending upon manufacturing location.

ORDERING INFORMATION

Device	Package	Shipping†
SL05T1	SOT-23	3000/Tape & Reel
SL05T1G	SOT-23 (Pb-Free)	3000/Tape & Reel
SL15T1	SOT-23	3000/Tape & Reel
SL15T1G	SOT-23 (Pb-Free)	3000/Tape & Reel
SL24T1	SOT-23	3000/Tape & Reel
SL24T1G	SOT-23 (Pb-Free)	3000/Tape & Reel
SL05T3	SOT-23	10,000/Tape & Reel
SL15T3	SOT-23	10,000/Tape & Reel
SL24T3	SOT-23	10,000/Tape & Reel

†For information on tape and reel specifications, including part orientation and tape sizes, please refer to our Tape and Reel Packaging Specifications Brochure, BRD8011/D.

DEVICE MARKING INFORMATION

See specific marking information in the device marking column of the table on page 3 of this data sheet.

SL05T1 Series

MAXIMUM RATINGS

Rating	Symbol	Value	Unit
Peak Power Dissipation @ 8x20 usec (Note 1) @ $T_L \leq 25^\circ\text{C}$	P_{pk}	300	W
IEC 61000-4-2 Level 4 Contact Discharge	V_{pp}	± 8	kV
Air Discharge		± 16	kV
IEC 61000-4-4 EFT		40	A
IEC 61000-4-5 Lightning		12	A
Total Power Dissipation on FR-5 Board (Note 2) @ $T_A = 25^\circ\text{C}$ Derate above 25°C	P_D	225	mW
Thermal Resistance Junction to Ambient	$R_{\theta JA}$	1.8	$\text{mW}/^\circ\text{C}$
Thermal Resistance Junction to Ambient	$R_{\theta JA}$	556	$^\circ\text{C}/\text{W}$
Total Power Dissipation on Alumina Substrate (Note 3) @ $T_A = 25^\circ\text{C}$ Derate above 25°C	P_D	300	mW
Thermal Resistance Junction-to-Ambient	$R_{\theta JA}$	2.4	$\text{mW}/^\circ\text{C}$
Thermal Resistance Junction-to-Ambient	$R_{\theta JA}$	417	$^\circ\text{C}/\text{W}$
Junction and Storage Temperature Range	T_J, T_{stg}	- 55 to +150	$^\circ\text{C}$
Lead Solder Temperature - Maximum (10 Second Duration)	T_L	260	$^\circ\text{C}$

Stresses exceeding Maximum Ratings may damage the device. Maximum Ratings are stress ratings only. Functional operation above the Recommended Operating Conditions is not implied. Extended exposure to stresses above the Recommended Operating Conditions may affect device reliability.

1. Non-repetitive current pulse per Figure 2
2. FR-5 = 1.0 x 0.75 x 0.62 in.
3. Alumina = 0.4 x 0.3 x 0.024 in., 99.5% alumina

ELECTRICAL CHARACTERISTICS

($T_A = 25^\circ\text{C}$ unless otherwise noted)

UNIDIRECTIONAL

Symbol	Parameter
I_{PP}	Maximum Reverse Peak Pulse Current
V_C	Clamping Voltage @ I_{PP}
V_{RWM}	Working Peak Reverse Voltage
I_R	Maximum Reverse Leakage Current @ V_{RWM}
V_{BR}	Breakdown Voltage @ I_T
I_T	Test Current
ΘV_{BR}	Maximum Temperature Coefficient of V_{BR}
I_F	Forward Current
V_F	Forward Voltage @ I_F
Z_{ZT}	Maximum Zener Impedance @ I_{ZT}
I_{ZK}	Reverse Current
Z_{ZK}	Maximum Zener Impedance @ I_{ZK}

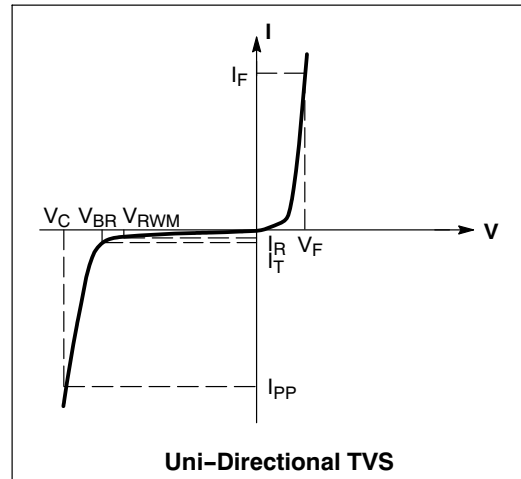

SL05T1 Series

ELECTRICAL CHARACTERISTICS

Device	Device Marking	V_{RWM} (V)	$I_R @ V_{RWM}$ (μA)	Breakdown Voltage (Note 4)		V_C , Clamping Voltage (Note 5)		Max I_{PP} (A)	Capacitance @ $V_R = 0 V$, 1 MHz (pF)	
				$V_{BR} @ 1 mA$ (Volts)		@ 1 A	@ 5 A		Typ	Max
				Min	Max	(V)	(V)			
SL05	L05	5.0	20	6.0	8.0	9.8	11	17	3.5	5.0
SL15	L15	15	1.0	16.7	18.5	24	30	10	3.5	5.0
SL24	L24	24	1.0	26.7	29	43	55	5.0	3.5	5.0

4. V_{BR} measured at pulse test current of 1 mA at an ambient temperature of 25°C

5. Surge current waveform per Figure 2

TYPICAL CHARACTERISTICS

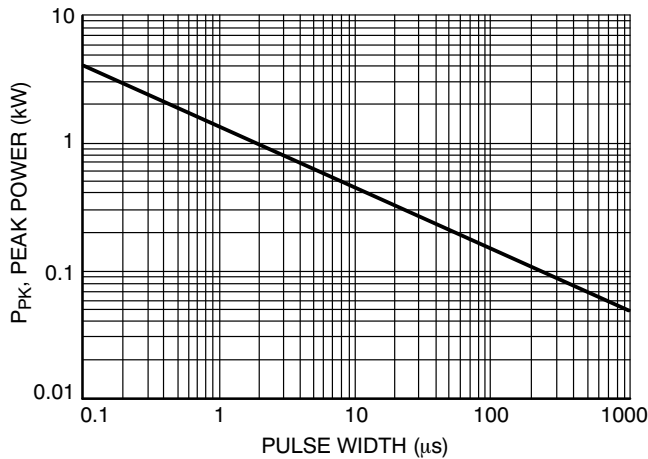

Figure 1. Maximum Peak Power Rating

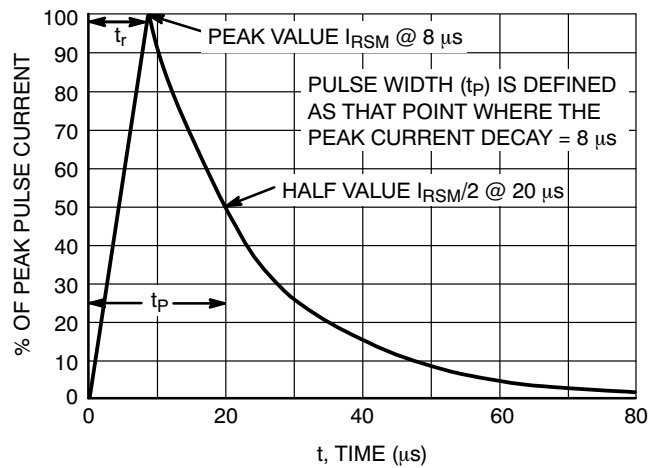

Figure 2. 8 × 20 μs Pulse Waveform

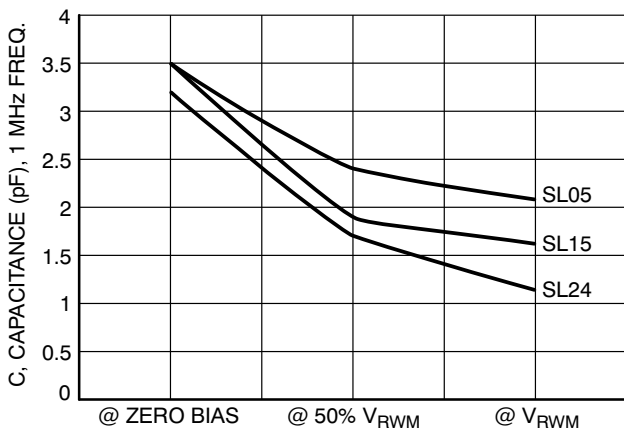

Figure 3. Typical Junction Capacitance

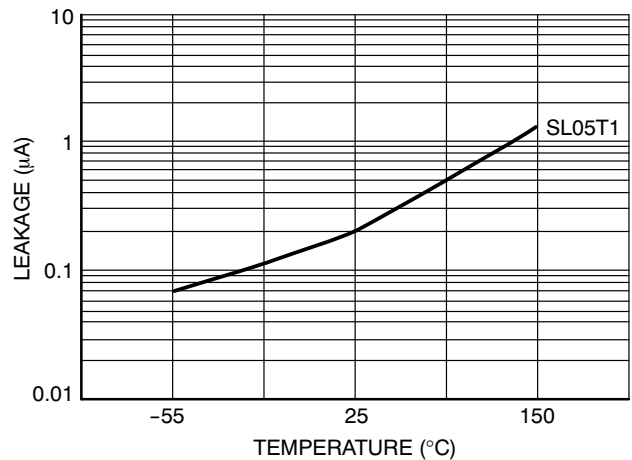

Figure 4. Typical Leakage Over Temperature

SL05T1 Series

Applications Background

This new family of TVS devices (SL05T1 series) are designed to protect sensitive electronics such as communications systems, computers, and computer peripherals against damage due to ESD conditions or transient voltage conditions. Because of their low capacitance value (less than 5 pF), they can be used in high speed I/O data lines. Low capacitance is achieved by integrating a compensating diode in series with the TVS which is basically based in the below theoretical principle:

- Capacitance in parallel: $C_T = C_1 + C_2 + \dots + C_n$
- Capacitance in series: $1/C_T = (1/C_1) + (1/C_2) + \dots + (1/C_n)$

The Figure 5 shows the integrated solution of the SL05T1 series device:

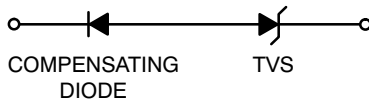

Figure 5.

In the case that an over-voltage condition occurs in the I/O line protected by the SL05T1 series device, the TVS is reverse-biased while the compensation diode is forward-biased so the resulting current due to the transient voltage is drained to ground.

If protection in both polarities is required, an additional device is connected in inverse-parallel with reference to the first one, the Figure 6 illustrates the inverse-parallel connection for bi-directional or unidirectional lines:

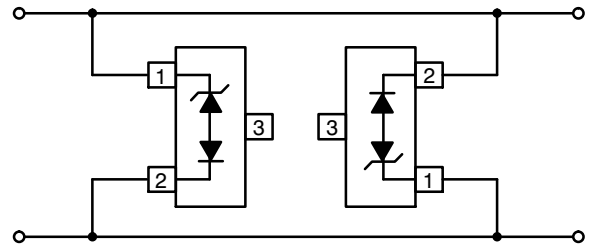

Figure 6.

An alternative solution to protect unidirectional lines, is to connect a fast switching steering diode in parallel with the SL05T1 series device. When the steering diode is forward-biased, the TVS will avalanche and conduct in reverse direction. It is important to note that by adding a steering diode, the effective capacitance in the circuit will be increased, therefore the impact of adding a steering diode must be taken in consideration to establish whether the incremental capacitance will affect the circuit functionality or not. The Figure 7 shows the connection between the steering diode and the SL05T1 series device:

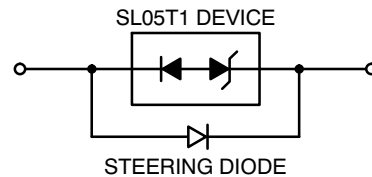

Figure 7.

Another typical application in which the SL05T1 series device can be utilized, is to protect multiple I/O lines. The protection in each of the I/O lines is achieved by connecting two devices in inverse-parallel. The Figure 8 illustrates how multiple I/O line protection is achieved:

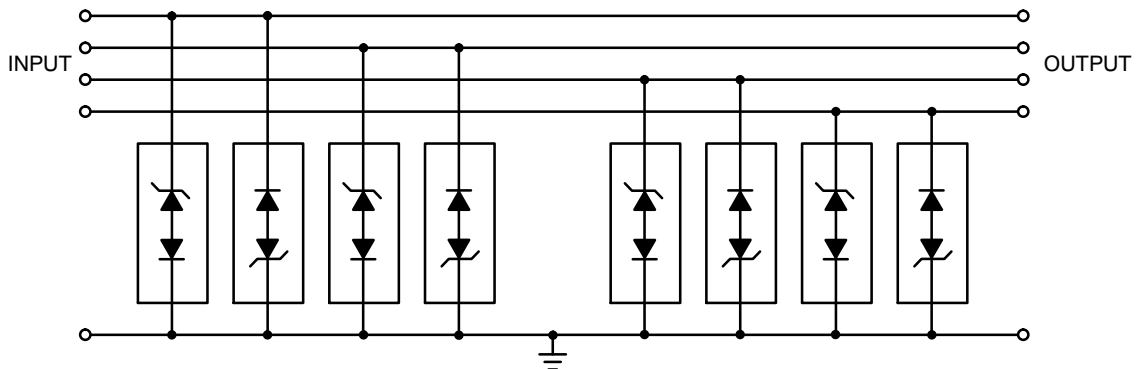

Figure 8.

For optimizing the protection, it is recommended to use ground planes and short path lengths to minimize the PCB's ground inductance.

SL05T1 Series

PACKAGE DIMENSIONS

SOT-23 (TO-236)
CASE 318-08
ISSUE AN

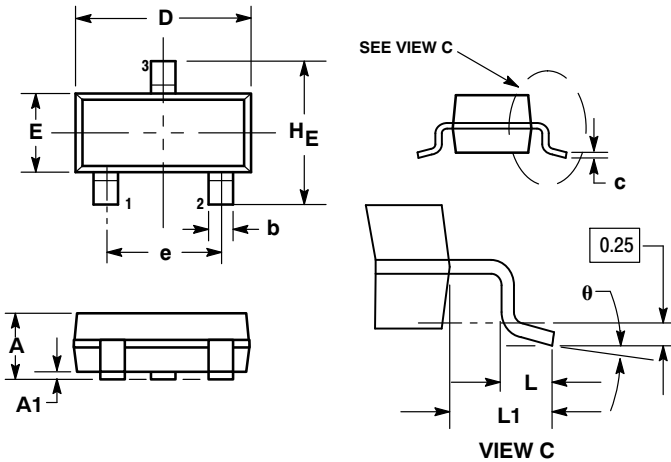

- NOTES:
1. DIMENSIONING AND TOLERANCING PER ANSI Y14.5M, 1982.
 2. CONTROLLING DIMENSION: INCH.
 3. MAXIMUM LEAD THICKNESS INCLUDES LEAD FINISH THICKNESS. MINIMUM LEAD THICKNESS IS THE MINIMUM THICKNESS OF BASE MATERIAL.
 4. 318-01 THRU -07 AND -09 OBSOLETE, NEW STANDARD 318-08.

DIM	MILLIMETERS			INCHES		
	MIN	NOM	MAX	MIN	NOM	MAX
A	0.89	1.00	1.11	0.035	0.040	0.044
A1	0.01	0.06	0.10	0.001	0.002	0.004
b	0.37	0.44	0.50	0.015	0.018	0.020
c	0.09	0.13	0.18	0.003	0.005	0.007
D	2.80	2.90	3.04	0.110	0.114	0.120
E	1.20	1.30	1.40	0.047	0.051	0.055
e	1.78	1.90	2.04	0.070	0.075	0.081
L	0.10	0.20	0.30	0.004	0.008	0.012
L1	0.35	0.54	0.69	0.014	0.021	0.029
HE	2.10	2.40	2.64	0.083	0.094	0.104

STYLE 26:
PIN 1. CATHODE
2. ANODE
3. NO CONNECTION

SOLDERING FOOTPRINT*

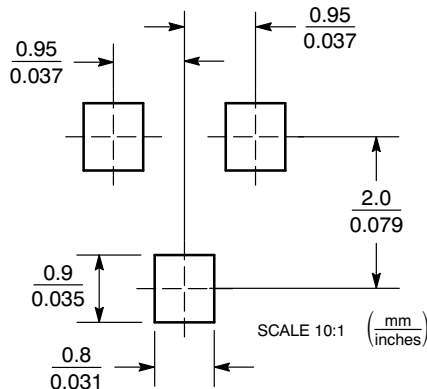

*For additional information on our Pb-Free strategy and soldering details, please download the ON Semiconductor Soldering and Mounting Techniques Reference Manual, SOLDERRM/D.

ON Semiconductor and are registered trademarks of Semiconductor Components Industries, LLC (SCILLC). SCILLC reserves the right to make changes without further notice to any products herein. SCILLC makes no warranty, representation or guarantee regarding the suitability of its products for any particular purpose, nor does SCILLC assume any liability arising out of the application or use of any product or circuit, and specifically disclaims any and all liability, including without limitation special, consequential or incidental damages. "Typical" parameters which may be provided in SCILLC data sheets and/or specifications can and do vary in different applications and actual performance may vary over time. All operating parameters, including "Typicals" must be validated for each customer application by customer's technical experts. SCILLC does not convey any license under its patent rights nor the rights of others. SCILLC products are not designed, intended, or authorized for use as components in systems intended for surgical implant into the body, or other applications intended to support or sustain life, or for any other application in which the failure of the SCILLC product could create a situation where personal injury or death may occur. Should Buyer purchase or use SCILLC products for any such unintended or unauthorized application, Buyer shall indemnify and hold SCILLC and its officers, employees, subsidiaries, affiliates, and distributors harmless against all claims, costs, damages, and expenses, and reasonable attorney fees arising out of, directly or indirectly, any claim of personal injury or death associated with such unintended or unauthorized use, even if such claim alleges that SCILLC was negligent regarding the design or manufacture of the part. SCILLC is an Equal Opportunity/Affirmative Action Employer. This literature is subject to all applicable copyright laws and is not for resale in any manner.

PUBLICATION ORDERING INFORMATION

LITERATURE FULFILLMENT:
Literature Distribution Center for ON Semiconductor
P.O. Box 5163, Denver, Colorado 80217 USA
Phone: 303-675-2175 or 800-344-3860 Toll Free USA/Canada
Fax: 303-675-2176 or 800-344-3867 Toll Free USA/Canada
Email: orderlit@onsemi.com

N. American Technical Support: 800-282-9855 Toll Free
USA/Canada
Europe, Middle East and Africa Technical Support:
Phone: 421 33 790 2910
Japan Customer Focus Center
Phone: 81-3-5773-3850

ON Semiconductor Website: www.onsemi.com
Order Literature: <http://www.onsemi.com/orderlit>
For additional information, please contact your local Sales Representative